



MAGNETIC LIFTERS

Electro Permanent Magnetic Plate Handling System

EPM Fixed Spreader Beam

Features

- EPMs suspended from fixed length spreader beam so that the maximum range of plates are covered.
- Optimise the available work area by elimination of dunnage.
- Electronic control panel along with standby PCB card.
- Double Mag Cycle - this ensures the safe lifting of the load.
- Power Control – Magnetic Power can be varied in 4 steps
- Magnets can be selectively switched according to the length of the plate being handled.
 - Smaller Plates – Only internal magnets are switched ON.
 - Larger Plates – All the magnets are switched ON.
- Safety Interlock Key – to Magnetize/ Demagnetize 2 buttons are to be pressed simultaneously. This eliminates the chance of accidental operation of the magnet.
- “Inching” feature –When the magnet is switched ON, it might lift more than a single plate. Inching is a feature, which when invoked reduces the magnetic power slowly such that additional plates, if lifted, are dropped. This is used to make sure that only one plate is handled at a time.
- ADPREM – Accidental Demagnetization PREvention Mechanism. Disable the demagnetization cycle when carrying load.
- Lamp Block – Displays the systems present state.
- Chain and Hanging Arrangement – made of grade 80 high strength steel along with bull ring.

Optional Units

- Radio Remote Control – Operates from a convenient distance all the functions i.e, MAG/DEMAG/Inching/ Telescopic Contraction and Expansion (if provided).

Application

- For loading/ unloading plates from Railway Wagons/ trucks.
- For storing in Plate yards.
- For feeding plates onto a flame/ plasma cutting machine table, one at a time.
- Can be used with EOT/ Gantry/ Mobile Cranes etc.



| Art No | Beam Weight (Apprx) kg | Magnet Specifications | | Plate Characteristics | | | | | Lifting Capacity kg |
|----------|---------------------------|-----------------------|-----------------|-----------------------|--------|-------|-------|------|------------------------|
| | | Number of Magnets | Magnet Distance | Th | Length | | Width | | |
| | L1 | | min | min | max | min | max | max | |
| 23102.01 | 750 | 5 (5x1) | 1050 | 5 | 500 | 6300 | 500 | 3000 | 2,000 |
| 23102.02 | 1200 | 4 (2x2) | 2800 | 5 | 3000 | 6300 | 500 | 3000 | 4,000 |
| 23102.03 | 1500 | 8 (4x2) | 2200 | 5 | 2500 | 12500 | 500 | 3000 | 5,000 |
| 23102.04 | 1800 | 8 (4x2) | 2200 | 5 | 2500 | 12500 | 500 | 3000 | 7,500 |
| 23102.05 | 2500 | 8 (4x2) | 2200 | 5 | 2500 | 12500 | 500 | 3500 | 10,000 |
| 23102.06 | 2800 | 8 (4x2) | 2200 | 8 | 2500 | 12500 | 500 | 3500 | 12,000 |
| 23102.07 | 3300 | 8 (4x2) | 2200 | 8 | 2500 | 12500 | 500 | 3500 | 16,000 |

| PERMISSIBLE OVERHANG OF PLATES | |
|--------------------------------|---------|
| TH - 5 mm | 1350 mm |
| TH - 6 mm | 1425 mm |
| TH - 8 mm | 1550 mm |
| TH - 10 mm | 1750 mm |
| TH - 12 mm | 1900 mm |

- Due to continuous upgradation in design there could be changes in specifications.
- Other sizes on request.

EPM Telescopic Spreader Beam



Features

The more versatile lifting magnet system with the additional features:

- One set of EPM placed on the fixed part of the spreader beam and another set placed on the telescopic part.
- The length of the system can be adjusted depending on the length of the plate being handled.
 - Shorter plates: activate only the inner magnets.
 - Medium plates: activate all the magnets with the telescopic arm in the closed position.
 - Long plates: activate all the magnets with the telescopic arm in the expanded position.

| Art No | Beam Weight (Apprx) kg | Magnet Specifications | | | | Plate Characteristics | | | | | Lifting Capacity kg |
|----------|---------------------------|-----------------------|-----------------|----------|------------------------------------|-----------------------|-----------|-----------|-----------|-----------|------------------------|
| | | Number of Magnets | Magnet Distance | | Magnet Extension (each side) mm | Th mm | Length | | Width | | |
| | | | L1 mm | L2 mm | | | min mm | max mm | min mm | max mm | |
| 23103.01 | 1500 | 8 (4x2) | 1500 | 750 | 750 | 5 | 1500 | 6300 | 500 | 3000 | 4,000 |
| 23103.02 | 2800 | 8 (4x2) | 2800 | 1600 | 1500 | 5 | 3000 | 12500 | 500 | 3000 | 7,500 |
| 23103.03 | 3000 | 8 (4x2) | 2800 | 1600 | 1500 | 5 | 3000 | 12500 | 500 | 3500 | 10,000 |
| 23103.04 | 3200 | 8 (4x2) | 2800 | 1600 | 1500 | 8 | 3000 | 12500 | 500 | 3500 | 12,000 |
| 23103.05 | 3800 | 8 (4x2) | 2800 | 1600 | 1500 | 8 | 3000 | 12500 | 500 | 3500 | 16,000 |

- Due to continuous upgradation in design there could be changes in specifications.
- Other sizes on request.



EPM Tilting Plate Handling System

Features

- Tilting Electro Permanent Magnets for handling Single plates in either vertical or horizontal position.
- “Inching” feature – drops additional plates making sure that only one plate is handled.
- Supplied along with fixed spreader beam.
- Simple self-tilting mechanism by appropriate positioning on plates lifted. No additional mechanism required.
- Horizontally placed plates can be stacked in vertical position or Vertically stacked plates can be kept in horizontal position by appropriate placement of the magnets.
- Spreader beam fitted with elastic suspension for EPMs/ control panel/ indicative tower lamp/ Chain & Bull Ring etc.
- Radio Remote Control integrated.



Application

- Unloading from trucks and stacking in vertical position.
- Typically from Vertical storage to a Flame/ laser/ plasma cutting table, etc.
- Can be used with EOT/ Gantry/ Mobile Cranes.

| Art No | Beam Weight (Apprx) kg | Magnet Specifications | | Plate Characteristics | | | | | Lifting Capacity max kg |
|-----------|------------------------|-----------------------|-----------------|-----------------------|--------|--------|--------|------|-------------------------|
| | | Number of Magnets | Magnet Distance | Th | Length | | Width | | |
| | | | L1 mm | min mm | max mm | min mm | max mm | | |
| 2310 4.01 | 2000 | 4 | 1500 | 5 | 1500 | 6300 | 500 | 2500 | 4,000 |
| 2310 4.02 | 3000 | 4 | 2800 | 5 | 3000 | 12500 | 500 | 3000 | 7,500 |
| 2310 4.03 | 3200 | 4 | 2800 | 5 | 3000 | 12500 | 500 | 3500 | 10,000 |
| 2310 4.04 | 3500 | 4 | 2800 | 5 | 3000 | 12500 | 500 | 3500 | 12,000 |
| 2310 4.05 | 4000 | 6 | 2000 | 5 | 3000 | 12500 | 500 | 3500 | 16,000 |

• Due to continuous upgradation in design there could be changes in specifications.
 • Other sizes on request.

EPM Billet Handling System



Features

- For handling Billets/Slab/Blooms.
- Supplied along with fixed spreader beam.
- Handling of Billets/ Blooms up to 600°C (in core).
- Single layer of material can be handled.

Application

- Typically for storing/ unloading & handling of billets.
- Hot billet in Steel Melting Shop can be handled.
- Can be used with EOT/ Gantry/ Mobile Cranes etc.



| Art No | Beam Weight | Magnet Specifications | | | | Billet Lifting Capacity | |
|----------|-------------|-----------------------|-------------|------|-----------------|-------------------------|--------|
| | | Number of Magnets | Magnet Size | | Magnet Distance | Length | Wt |
| | | | W | L | Lm | | |
| | | | mm | mm | mm | | |
| 23106.01 | 800 | 1 | 600 | 900 | - | 3000 | 3,000 |
| 23106.02 | 1500 | 2 | 460 | 900 | 2000 | 6000 | 5,000 |
| 23106.03 | 2000 | 2 | 560 | 1350 | 3000 | 12000 | 8,000 |
| 23106.04 | 3000 | 2 | 560 | 1700 | 3000 | 12000 | 10,000 |



- Due to continuous upgradation in design there could be changes in specifications.
- Other sizes on request.

Modular Electro Permanent Magnets - Build your own Systems

Features

- Electro Permanent Magnets in module with mounting holes.
- Each magnet is completely sealed with no moving parts.
- Magnets with Safety factor of 3.
- Spring Suspension Box can be added to take care of waviness of plate.

Note:

- The modules can be integrated with our controllers for EPM lifting magnet systems with all its features.
- ADPREM can also be integrated into the magnet module.

Application

- EPM Modules can be suspended from existing spreader beam.
- Can be used as Robotic Grip.
- Multiple modules can be added on a spreader beam to handle longer plates.



System fabricated using

- EPM Lifting Magnets.
- ADPREM – hook plate.
- Spring Box
- Control Panel
- Cable Reeling Drum

| Art No. | Magnet Dimension | | Self Weight | Maximum Plate Size | Tear Off Capacity | Lifting Capacity |
|----------|------------------|-----|-------------|--------------------|-------------------|------------------|
| | L | W | | | | |
| | mm | mm | kg | mm | kg | kg |
| 23105.01 | 170 | 170 | 20 | 1500x1500 | > 900 | 300 |
| 23105.02 | 290 | 170 | 30 | 1500x2000 | > 1500 | 500 |
| 23105.03 | 330 | 240 | 45 | 2000x2000 | > 2250 | 750 |
| 23105.04 | 325 | 235 | 45 | 2000x2500 | > 3000 | 1000 |
| 23105.05 | 415 | 235 | 55 | 2500x2500 | > 3750 | 1250 |
| 23105.06 | 505 | 235 | 65 | 2500x3000 | > 4500 | 1500 |
| 23105.07 | 630 | 250 | 90 | 3000x3000 | > 6000 | 2000 |

- Due to continuous upgradation in design there could be changes in specifications.
- Other sizes on request.

Special Applications

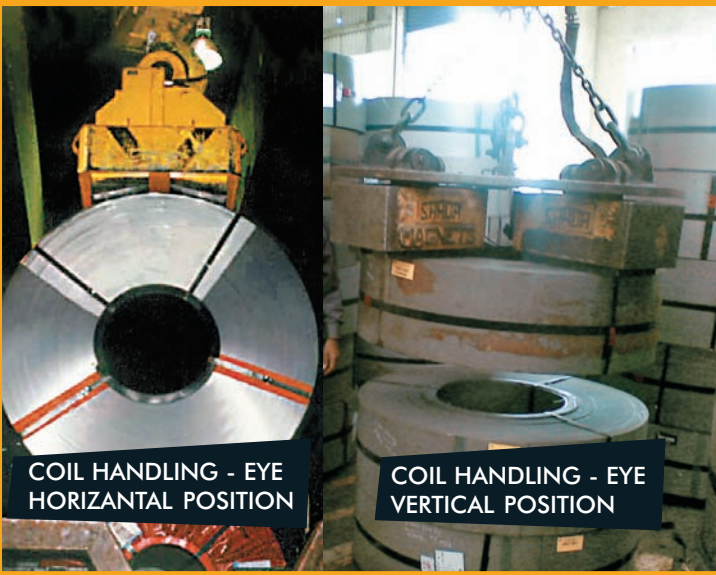

Controllers

Control Panel EPM

Features

- Power station of the Electro Permanent Magnetic Lifters in compact IP54 cabinet.
- Available in Single / Multi Channels.
- Power variation in 4 steps.
- Has Magnetization/ Common/ Demagnetization/ Contraction and Expansion (if applicable) Push Buttons.
- Dual Magnetisation Cycle with safety push button.
 - 1st Shot – 75% to check safe lifting capability.
 - 2nd Shot – 100% to ensure safe travel.
- Standby spare PCB provided inside the panel to ensure non-stop working and reduce downtime.
- Fitted with Indication Tower Block along with audio alarm to display the system's present state.
- "ADPREM" (Accidental Demagnetization PREvention Mechanism) ready.
- Radio Remote Control Ready.

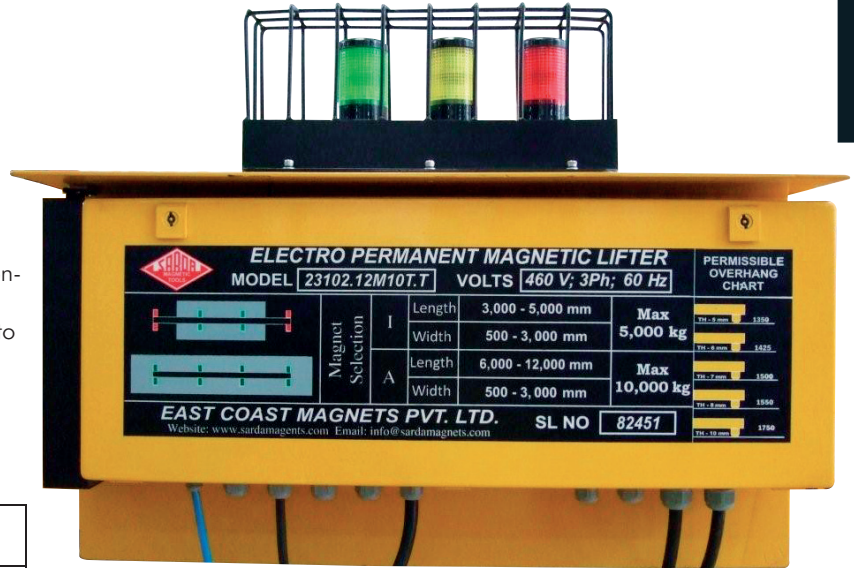

| Art No | No of Channels | Spreader Beam Type | Operating Voltage | | Rated Capacity |
|----------|----------------|--------------------|-------------------|----|----------------|
| | | | V AC | A | |
| 93109.01 | 1 | Fixed | 440 | 50 | |
| 93109.02 | 2 | Fixed | 440 | 50 | |
| 93109.03 | 2 | Telescopic | 440 | 50 | |

- Due to continuous upgradation in design there could be changes in specifications.
- Other sizes on request.

Radio Remote Control

Features

- Gives flexibility to operator to stand at a convenient place and operate the magnet – means more safety of operator.
- Enables the operation of Pickup/ Magnetization/ Demagnetization/ Inching/ telescopic expansion/ telescopic contraction (if applicable).
- Compact receiver box can be easily fitted inside the control panel.
- Can operate the magnet from 100 meters distance.



| Art No | Range meter | Supply Voltage | | Number of Buttons |
|----------|----------------|----------------|-------------|-------------------|
| | | Receiver | Transmitter | |
| | | V DC | V DC | |
| 90110.01 | 100 | 12/ 24 | 9 | 2 |
| 90110.02 | | | | 4 |
| 90110.03 | | | | 6 |
| 90110.04 | | | | 8 |
| 90110.05 | | | | 10 |

- Due to continuous upgradation in design there could be changes in specifications.
- Other sizes on request.

Cable Reeling Drums

Features

- Spring Operated Cable Reeling Drums gives automatic reeling and unreeling of flexible cables for up/ down movement in cranes for power supply to Lifting Magnets.
- Self Coiling Reels are used for simple installation up to 15 Meters Height.
- Generally mounted parallel to main hoist on the trolley.
- Special type Sprocket/Motor driven CRD is available.
- Slip ring less Cable Reeling Drum and CRD with stall torque motor drive also available.
- CRD available up to 40 Meters Coiling Length.
- The CRD comes along with a junction box at the end of the cable which can be mounted on the crane Shank head along with plug and socket.



ART No. 90111.03

Application

- Used for giving power supply to Electro/ Electro Permanent Magnets from Crane top.
- In single girder cranes, small CRD's are mounted on separate trolley attached with cross travel.
- Special type compact CRD for Hydra and other Mobile Crane application.

For sprocket driven, details of Crance hoist rope drum dia, no. of falls of wire rope etc., are required.

| Art No | Drum Dia | No of Dead Turns | Can accommodate cable upto | Cable Reeling Length |
|----------|----------|------------------|----------------------------|----------------------|
| | mm | | | M |
| 90111.01 | 250 | 2 | 3 x 2.5 mm ² | 4 |
| 90111.02 | 400 | 2 | 3 x 6 mm ² | 12 |
| 90111.03 | 400 | 2 | 3 x 6 mm ² | 15 |
| 90111.04 | 450 | 2 | 9 x 2.5 mm ² | 15 |

- Due to continuous upgradation in design there could be changes in specifications.
- Other sizes on request.



ART No. 90111.02

ART No. 90111.04

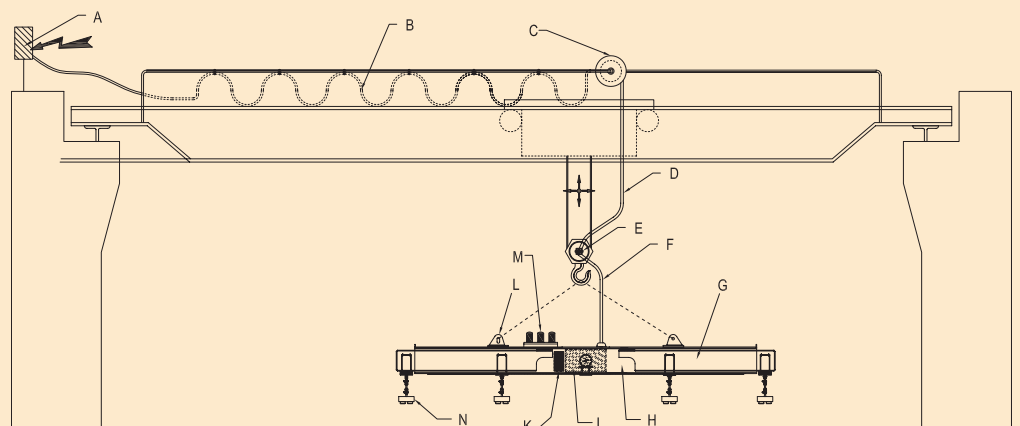

- A) Mains switch 440 V 3ph 50 / 60 Hz 50 kVA (Cycle Time 6 sec.)
- B) Festoon Crane Cable
- C) Cable Reeling Drum
- D) Cable of drum reel
- E) Plug / socket
- F) Discharge cable from Magnet
- H) Spreader Beam
- I) Electronic Controller
- J) Radio Remote Control
- K) Telescopic Accuator (*)
- L) ADPREM
- M) Cycle lamps
- N) Electro Permanent Magnets

Battery Operated Electro Permanent Magnetic Lifter

Self contained -
hook to crane & lift



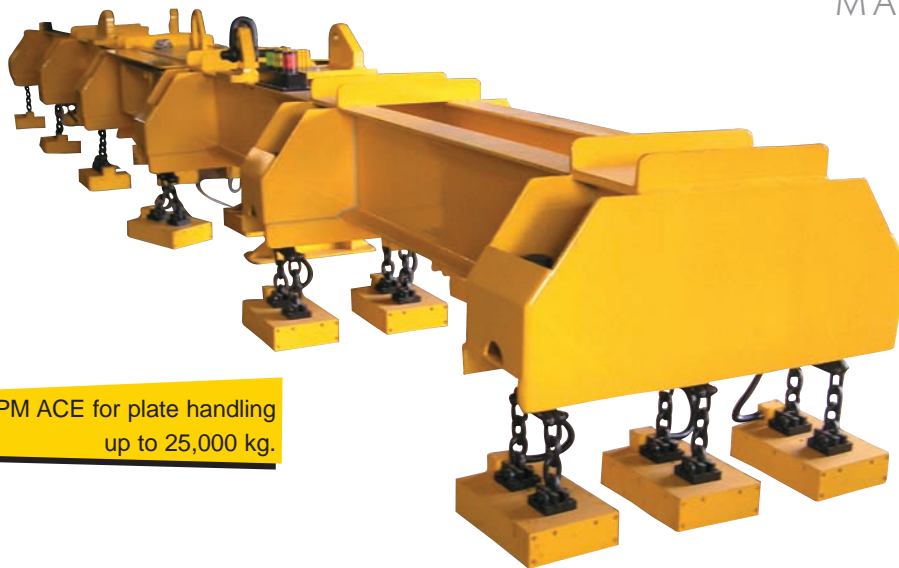

**BATEPM ACE for plate handling
up to 25,000 kg.**

Features

- Revolutionary technique for safe magnetic lifting.
- Light weight and robust construction.
- Safety factor of 2 is maintained for each magnet.
- EPM Lifter-Battery power only needed to switch On and Off.
- No battery power is needed to keep magnet On.
- 2 Pole design for lifting both round and flat components.
- Maintenance free completely sealed rechargeable batteries.
- With battery fully charged - can switch On/Off approximately 300 times.
- Warning signal when battery charge level is low.
- In built battery charger with over charge protection.
- Battery Charging cable is in built in a sliding case.
- Automatic Sequential switching On/Off using contact less relay. The magnet initially is in Off condition. After placing on the load, as the magnet pulls up, it actuates a contact less relay and the magnet is auto-matically switched On. When it is hoisted down, the magnet remains On. Now when it is lifted the same is switched OFF and release the job.
- Ready to use Magnets can be hooked to crane giving incredible flexibility and unbeaten cost reduction for moving ferrous load.
- BATEPM ACE is made with multiple magnets for handling longer sheets/ bars plates.

Applications

- Near flame cutting machines.
- In stock yards for handling flats, plates, rounds.
- For loading / unloading on machine tools like grinding, CNC Milling, lathes, power saw and during assembly.
- Since no mechanical lever is actuated, very comfortable for operator even while working at odd site condition.
- Radio Remote Control (Optional).

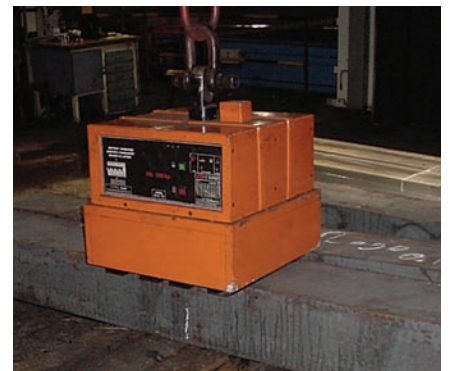

| Art No. | LIFTING Flat Load (Kg) | Canaceing Round Load (Kg) | Battery (VDC) | Charging (VAC) | Self Weight (Kg) |
|----------|------------------------|---------------------------|---------------|----------------|------------------|
| 23101.01 | 1500 | 750 | 2 x 12 | 230 | 120 |
| 23101.02 | 3000 | 1500 | 2 x 12 | 230 | 200 |
| 23101.03 | 5000 | 2500 | 2 x 12 | 230 | 375 |

- Due to continuous upgradation in design there could be changes in specifications.
- Other sizes on request.



MAGNALIFT Electro Magnetic Circular Lifters

Features

- Easy & speedy handling of solids and scraps.
- Compact and Light weight models are available with optimum load carrying capacity.
- Optimum cross section combined with high magnetic flux produced ensures maximum lifting capacity with respect to the magnet self weight.
- Special Heavy Steel Mill Duty Series with Heavy Duty Manganese Casting Bumper Plate also available with deep field design, Higher Duty Cycle for enhanced Magnetic Operation and Higher Lifting Capacity.
- Manufactured with Cast Steel body and/or Fabricated structure.
- Duty Cycle 50%/ 60%/ 75% per 10 minute.
- Aluminium/Copper/Anodised Aluminium Conductor wound coil, special "H" or "C" Class insulation.
- Completely sealed with thermal conductive compound and protected terminal box.
- Supplied along with standard three-fall chain suspension with bull ring.
- Non Linear Resistors for surge suppression (optional).
- Operates on 220 Volts DC, other voltage on request.
- Compact Heavy duty control panel with easy maintenance.
- Lead Acid/Ni-cd Battery Back-up with Charger.
- Cable Reeling Drums in various types are available.



Steel Mill Duty Series



Heavy Duty Series



Application

- Loading/unloading of steel scraps/pig irons/ cast iron/boring/turning/broken steel.
- Handles slabs, blooms and ingots.
- Handle plates/angle/channels.
- Used in smelt mixing operation.
- Can be used with mobile cranes.
- Direct feeding in the furnace.
- Sweeping/cleaning of mill area.

HEAVY DUTY SERIES

| Art No | Dia of Magnet | Rated Power | Approx. weight | Slab ingot | Pig Iron | Cast iron Scrap (Grade 3a) | Solid Scrap (Grade 24) | Short Steel Turnings (Grade 40) |
|----------|---------------|-------------|----------------|------------|----------|----------------------------|------------------------|---------------------------------|
| | (mm) | (KW) | (Kg) | (Kg) | (Kg) | (Kg) | (Kg) | (Kg) |
| 22205.01 | 700 | 2.5 | 365 | 4000 | 215 | 175 | 165 | 75 |
| 22205.02 | 900 | 4 | 650 | 6945 | 375 | 300 | 280 | 130 |
| 22205.03 | 1000 | 4.5 | 880 | 8815 | 485 | 390 | 365 | 170 |
| 22205.04 | 1100 | 6.0 | 1250 | 11345 | 640 | 500 | 490 | 225 |
| 22205.05 | 1300 | 8.5 | 1820 | 16265 | 975 | 780 | 745 | 340 |
| 22205.06 | 1600 | 11 | 2740 | 23000 | 1400 | 1150 | 1100 | 500 |
| 22205.07 | 1800 | 13.9 | 3670 | 30010 | 2000 | 1600 | 1500 | 700 |
| 22205.08 | 2000 | 17.2 | 4750 | 35450 | 2575 | 2070 | 1960 | 900 |

STEEL MILL DUTY SERIES

| Art No | Dia of Magnet | Rated Power | Approx. weight | Slab ingot | Pig Iron | Cast iron Scrap (Grade 3a) | Solid Scrap (Grade 24) | Short Steel Turnings (Grade 40) |
|----------|---------------|-------------|----------------|------------|----------|----------------------------|------------------------|---------------------------------|
| | (mm) | (KW) | (Kg) | (Kg) | (Kg) | (Kg) | (Kg) | (Kg) |
| 22206.01 | 1130 | 8 | 1520 | 14700 | 800 | 700 | 650 | 300 |
| 22206.02 | 1350 | 10.5 | 2320 | 22000 | 1250 | 1100 | 1000 | 500 |
| 22206.03 | 1440 | 12.5 | 2850 | 26300 | 1500 | 1300 | 1200 | 600 |
| 22206.04 | 1550 | 14 | 3380 | 30500 | 1750 | 1500 | 1400 | 700 |
| 22206.05 | 1600 | 14.5 | 3550 | 31000 | 1800 | 1550 | 1450 | 725 |
| 22206.06 | 1750 | 18 | 5320 | 39500 | 2350 | 2050 | 1900 | 950 |
| 22206.07 | 1840 | 20 | 6130 | 44500 | 2650 | 2350 | 2200 | 1100 |
| 22206.08 | 2020 | 23.5 | 8150 | 56000 | 3300 | 3000 | 2800 | 1350 |
| 22206.09 | 2250 | 27.5 | 10600 | 68500 | 4000 | 3700 | 3500 | 1700 |

- Due to continuous upgradation in design there could be changes in specifications.
- Other sizes on request.

MAGNALIFT Electro Magnetic Rectangular Lifters



Bi-polar magnet coil handling upto dia 1200x3000 mm long.



Features

- Manufactured in fabricated structure & also in Cast body.
- Compact, light weight & increased heavy duty cycle.
- Aluminium/Copper/Anodised Aluminium Conductor wound coil, special "H" or "C" Class insulation.
- Completely sealed with thermal conductive compound and protected terminal box.
- Custom designed poles for special profiles.
- Operates on 220 Volts DC.
- Magnets for handling hot materials upto 600°C also available.
- Optional battery back up can be supplied.
- The ordering code for Aluminium wined lifters are 22102.
- The ordering code for Anodised Aluminium wined lifters are 22103.
- Spreader beams suitable for 12/ 24 Mts long billets/ plates/ Re-bars are also supplied as per customer's specification.



Applications

- Useful for production and stock yards.
- Loading/unloading of steel plates/billets/bars/blooms from trucks.
- Handles slabs, blooms and ingots.
- Can be used in tandem from spreader beam.
- Special design for handling large coils.



Technical Specifications

All dimensions are in mm.

| Art No. | W | L | H | Self Weight (Kg) | Power (KW) | Size | Billet Length (M) | Billet Lifting Capacity (Kg) |
|----------|-----|------|-----|------------------|------------|---------|-------------------|------------------------------|
| 22101.01 | 560 | 900 | 380 | 1200 | 5.00 | 5 x 130 | 6 | 5000 |
| 22101.02 | 560 | 1200 | 380 | 1650 | 6.00 | 7 x 130 | 6 | 7000 |
| 22101.03 | 560 | 1600 | 380 | 2000 | 7.00 | 8 x 150 | 6 | 10000 |
| 22101.04 | 700 | 1700 | 380 | 2800 | 7.50 | 6 x 230 | 6 | 12000 |
| 22101.05 | 900 | 2000 | 380 | 5000 | 12.00 | 3 x 550 | 6 | 20000 |

- Due to continuous upgradation in design there could be changes in specifications.
- Other sizes on request.



e-lift Permanent Magnetic Lifter

Features

- Tested to 3 times the rated lifting capacity.
- State of art design.
- Smaller and lighter than ever.
- Made with high energy rare earth NdFeB magnets.
- All Steel body and thus very stable.
- Easily transportable.
- Actuating lever with positive spring lock.

Applications

- For handling of steel plates, blocks, rounds, press moulds and loading/unloading on machines.
- Commonly used near flame cutting.
- Very handy during fabrication.
- Can handle finished components without leaving behind any scratch marks, unlike binding and slinging.
- Can be used with spreader beam hanging multiple magnets for long plates/pipes/bars.
- Can be used with mobile cranes.

Benefits

- More effective use of floor space by eliminating dunnage & increasing stacking height.
- Large and heavy work piece can be moved safely and easily by a single operator.
- Suitable for both flat and round components.
- Labour saving, time saving.



ART NO. 21101

ESSENTIAL - for productivity

EASY - to operate

ECONOMICAL - to purchase



EVER Lasting



All dimensions are in mm.

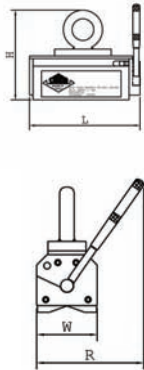

| Art No. | Lifting Capacity | | Dimensions | | | | Self Weight (Kg) | TFL (Kg) | Job Size Range | | |
|----------|------------------|----------|------------|-----|-----|-----|------------------|----------|----------------|------|-----------|
| | Flat (Kg) | Dia (Kg) | L | W | H | R | | | L | W | (Ø) |
| 21101.01 | 100 | 45 | 135 | 70 | 140 | 160 | 4 | 300 | 1200 | 800 | 40 - 100 |
| 21101.02 | 200 | 90 | 175 | 70 | 140 | 160 | 6 | 600 | 1200 | 800 | 40 - 100 |
| 21101.03 | 300 | 125 | 195 | 90 | 170 | 210 | 9 | 900 | 2000 | 1200 | 40 - 160 |
| 21101.04 | 500 | 225 | 255 | 100 | 210 | 180 | 18 | 1500 | 2500 | 1500 | 40 - 200 |
| 21101.05 | 1000 | 450 | 355 | 142 | 290 | 375 | 43 | 3000 | 3000 | 2000 | 60 - 350 |
| 21101.06 | 2000 | 900 | 445 | 182 | 335 | 430 | 88 | 6000 | 3500 | 2000 | 80 - 400 |
| 21101.07 | 3000 | 1350 | 470 | 260 | 425 | 750 | 175 | 9000 | 3500 | 2000 | 80 - 400 |
| 21101.08 | 5000 | 2250 | 540 | 370 | 515 | 750 | 350 | 15000 | 5000 | 3000 | 125 - 450 |

| Thickness | | Rated Capacity (SWL) | | | | | | | |
|-----------|----|----------------------|------|------|------|------|------|------|------|
| | | 5000 | 3000 | 2000 | 1000 | 500 | 300 | 200 | 100 |
| T1 | 70 | 100% | 100% | 100% | 100% | 100% | 100% | 100% | 100% |
| T2 | 60 | 90% | | | | | | | |
| T3 | 50 | 85% | | | | | | | |
| T4 | 45 | 80% | | | | | | | |
| T5 | 40 | 70% | 80% | 85% | 90% | 90% | 100% | 100% | |
| T6 | 35 | 70% | 70% | 75% | 85% | | | | |
| T7 | 30 | - | - | 60% | 65% | 80% | 80% | 90% | 90% |
| T8 | 25 | | | 55% | 70% | 80% | | | |
| T9 | 20 | | | 45% | 60% | 75% | 75% | 90% | 90% |
| T10 | 15 | | | 50% | 60% | 70% | | | |
| T11 | 10 | - | - | - | 45% | 50% | 70% | 70% | |
| T12 | 5 | | | | - | 30% | 40% | 40% | |

- Testing plate thickness 60 mm. (90 mm for Art. No. 21101.08)
- Lifting capacity depends with: - Thickness of load - Roughness of job surface - Hardness of material - Contact area of magnet - Temperature of the load.



Loading on Machine Bed



Spreader Beam With Adjustable Magnets.



Calculation of Lifting Capacity of a Lifting Magnet: = T x S x M x A X C X SWL

Example:

$$T4 \times S2 \times M2 \times A2 \times C1 \times 1000$$

$$100\% \times 90\% \times 90\% \times 75\% \times 100\% \times 1000 = 607.5 \text{ Kg}$$

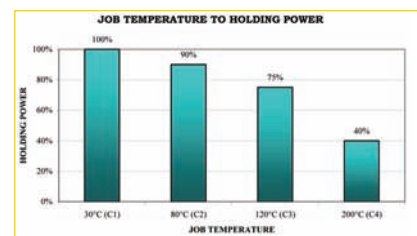
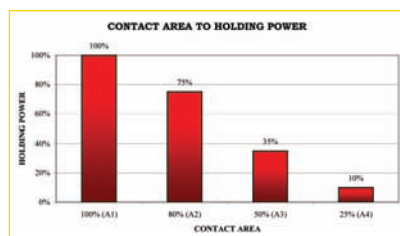
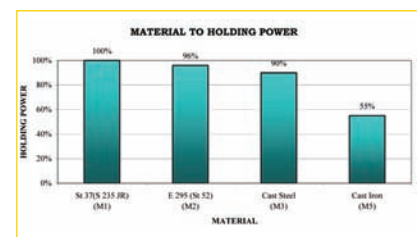
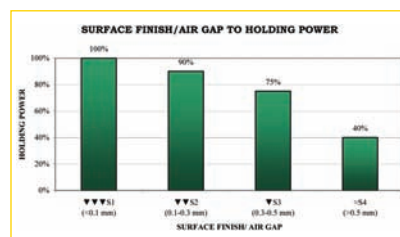

- Due to continuous upgradation in design there could be changes in specifications
- Other sizes on request.

Small Lifters

h - LIFT

Hand Drag Sheet Lifters

ART NO. 21102



Features

- Easy grip powerful magnet with handle.
- Can lift/ drag top sheet from stack for pulling out without any damage.
- Optimum flux density – effectively lifts thick/ thin sheets.
- Magnets are always ON. To release, a cam mechanism pushes down the sheet at contact point.

Applications

- Useful in press shops for feeding one sheet at a time in machine.
- Used as single or in pairs for carrying sheets for either horizontal or vertical transportation.
- Two people can hold from side for carrying sheet of dimension 3 x 1250 x 2500 mm.



All dimensions are in mm.

| Art No. | W | L | H | Lift Capacity (Kg) | Sliding Force (Kg) | Weight (Kg) |
|----------|-----|-----|----|--------------------|--------------------|-------------|
| 21102.01 | 100 | 150 | 35 | 90 | 35 | 3.0 |
| 21102.02 | 140 | 190 | 40 | 160 | 60 | 7.5 |

Caution: • Do not use it as a hoist • For handling finished components after grinding operation, use thin plastic sheet to avoid scratch.



S - LIFT

Sheet Lifters

ART NO. 21103



Features

- Simple, easy, flexible, economical and light weight.
- Can swivel 150° and lift sheets vertically and horizontally.
- Can lift non homogeneous parts with unbalanced weight and load.
- Optimum flux density – effectively lifts thick/ thin sheets.
- Magnets always remain ON.
- Cam mechanism jack up lever releases the jobs easily with the help of long handle.

Applications

- Useful in shop floor for stacking of sheets size upto 1250 x 2500 mm.
- Loading/unloading of plates from planners, boring, milling machine.
- Most suitable near flame cutting machines.

All dimensions are in mm.

| Art No. | W | L | Lift Capacity (Kg) | Sliding Force (Kg) | Weight (Kg) |
|----------|-----|-----|--------------------|--------------------|-------------|
| 21103.01 | 110 | 210 | 250 | 75 | 6.5 |
| 21103.02 | 180 | 320 | 500 | 150 | 13.5 |

- Due to continuous upgradation in design there could be changes in specifications.
- Other sizes on request.



Caution:

For handling finished components after grinding operation, use thin plastic sheet to avoid scratch.



TOUCHER MAGNET

ART NO. 21104

Features

- Handy with easy gripper.
- Attracts and removes with one touch jack up lever.
- Low field magnetic power to handle finished components.
- Can handle oily/ warm components.

Applications

- To hold small/complex shaped components while polishing/grinding.
- To lift oily finished grinded jobs from surface grinding machine.
- Useful during critical welding application.

All dimensions are in mm.

| Art No. | W | L | H | Lift Capacity (Kg) | Weight (Kg) |
|----------|-----|----|----|--------------------|-------------|
| 21104.01 | 100 | 60 | 40 | 25 | 1.2 |



MAGNETIC TONG

ART NO. 21105

Features

- Handy with long reach.
- Keeps hands away from power press.
- Low magnetic field to lift thin sheets.
- One touch release of components.

Applications

- To feed small components in power press.
- To remove punched component from press.

All dimensions are in mm.

| Art No. | W | L | H | Lift Capacity (Kg) | Weight (Kg) |
|----------|----|----|-----|--------------------|-------------|
| 21105.01 | 50 | 30 | 300 | 5 | 0.75 |



PALM MAGNET

Features

- Can be strapped in hand over gloves.
- Handy magnet with multiple use.
- Low field magnetic power to handle thin sheets one by one.
- Release the components manually.

Applications

- To feed small punched components in power press.
- Used as wrist watch to hold critical components during assembly.

All dimensions are in mm.

| Art No. | W | L | H | Lift Capacity (Kg) | Weight (Kg) |
|----------|----|----|----|--------------------|-------------|
| 21106.01 | 50 | 38 | 20 | 5 | 0.50 |

- Due to continuous upgradation in design there could be changes in specifications.
- Other sizes on request.



MR. MAGNALIFT SAYS

"Get the best out of your magnet!"

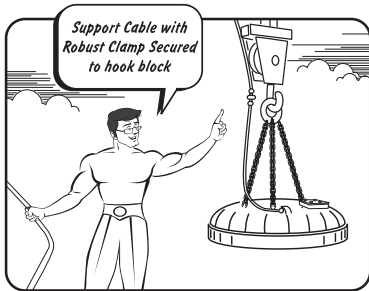

Support Cable with Robust Clamp Secured to hook block

Insecure cable can shear causing damage to controller or magnet due to inductive voltage surge.

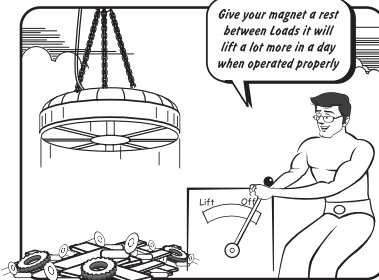

Give your magnet a rest between Loads it will lift a lot more in a day when operated properly

Lifting magnets are intermittent rated, and will overheat if left on. A hot magnet will not lift as much or last as long.

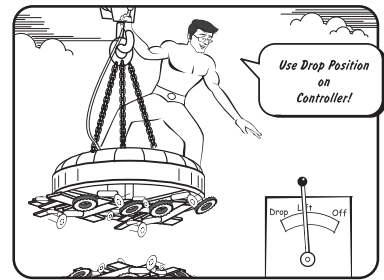

Use Drop Position on Controller!

For clean discharge of load the controller must be operated correctly and precisely

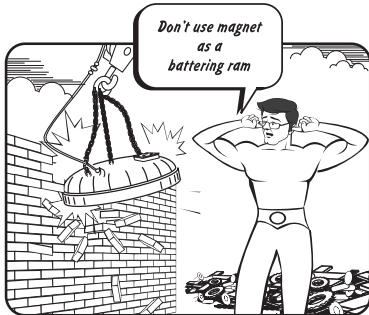

Don't use magnet as a battering ram

The magnet shell is robustly constructed but will not last as long if subjected to this treatment

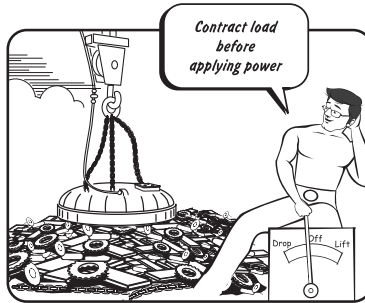

Contract load before applying power

The magnet will lift more as it avoids pieces jumping up and preventing magnet contacting pile.



Keep magnet dry

When not in use store the magnet under cover or use a tarpaulin. Don't put it on the ground to cool-use a stand-this prevents absorption of moisture into the shell.

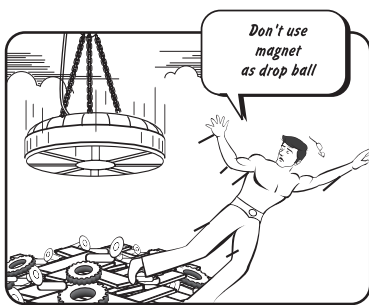

Don't use magnet as drop ball

If you want to break large piece of scrap or slag use a skull cracker ball with magnet.

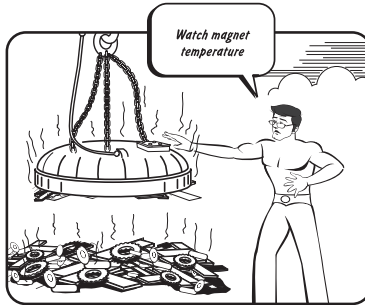

Watch magnet temperature

When handling slabs or ingots switch to a spare magnet. This saves electrical break down. Remember a hot magnet will not lift as much as when its cool.

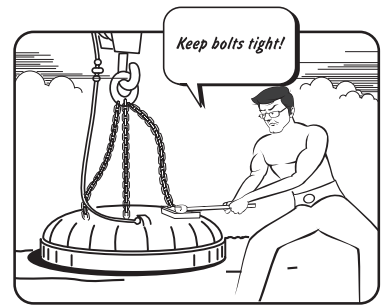

Keep bolts tight!

Check bolts chains periodically. This prevents moisture creeping through joint in magnet and terminal box which may cause short circuits,



EAST COAST MAGNETS PRIVATE LIMITED 100% EOU

44/1/6, Phase 1, I.D.A. Jeedimetla, Hyderabad - 55, India
Ph.: (91-40) 2309 8262 • Fax: (91-40) 2309 8261
E-mail: info@sardamagnets.com
Website: www.sardamagnets.com

EAST COAST ENTERPRISERS LIMITED

33, Brabourne Road, Kolkata - 01, India
Ph.: (91-33) 2242 1796 • Fax: (91-33) 2242 6568
E-mail: info@sardamagnets.com
Website: www.sardamagnets.com